

USER MANUAL



Laboratory Freezer Range



Please read and
keep these
instructions

Applicable models:

LSF151

LSF232

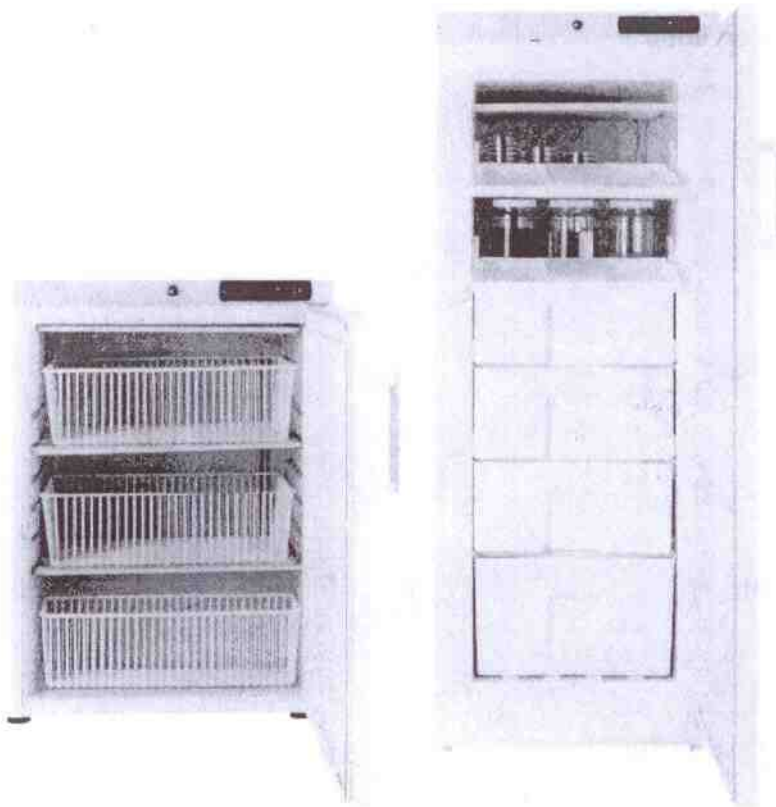

Contents

Before first use	3
Positioning of freezer	3
Transportation and moving of freezer	3
Energy saving tips	4
Important information	4
Product information	4
Product details	5
Controller overview	6
Viewing and resetting minimum and maximum temperatures	7
Changing the factory set point	8
Changing the temperature scale	8
Changing the remote alarm contacts	9
Alarms	10
Remote alarm contacts	10
Maintenance and Servicing	12
Defrosting	12
Cleaning	12
Reversing the door	13
Storage	13
Electrical Connection	15
Disposal	16
Troubleshooting	17
Contact Information	18

Thank you for purchasing this Lec Medical product. Before you first use this laboratory freezer please carry out the following actions:

- Check that the freezer has not been damaged in any way during transportation.
- If any damage is found it must be reported to our customer services department immediately on 0844-815-3755
- Ensure all packaging has been removed, including cardboard, polystyrene and any tape used to hold shelves in place for transportation.
- The freezer has been cleaned prior to despatch; however, we advise that it should be cleaned using lukewarm water containing a mild detergent and a soft cloth.
- We recommend that the freezer should be left in an upright position for 24 hours prior to switching on.
- This appliance is intended for professional use in applications such as pharmacies, laboratories, medical facilities etc.
- This appliance is not intended for use by persons (including children) with reduced physical, sensory or mental capabilities, or lack of experience and knowledge, unless they have been given supervision or instruction concerning use of the appliance by a person responsible for their safety.
- Children should be supervised to ensure that they do not play with the appliance.

Positioning and safely using your Lec Medical Freezer

- Make sure the appliance is placed in a dry, well ventilated site, away from heat sources.
- The appliance must be placed on a level surface. If necessary, adjust the feet on the product so the appliance remains level during operation.
- The appliance should have sufficient clearance around it to provide adequate ventilation – 10cm at each side, 6cm at the rear and 2.5cm at the top.
- Before ANY maintenance activity, pull the plug out of the socket by gripping the plug, DO NOT pull on the plug cord.
- DO NOT use double-wire extension cords. If an extension cord is necessary make sure it is a cord, which possess a protection safety certificate.
- If the main power supply cord is damaged, it should be replaced by a qualified service engineer.
- DO NOT attempt any repairs to the appliance yourself (apart from those highlighted in the Maintenance and Service Section). Repairs carried out by someone without the relevant training are putting their personal safety at risk and will invalidate your warranty.
- Do not store explosive substances such as aerosol cans with a flammable propellant in this appliance.
- **WARNING:** this appliance is only to be operated by authorised personnel or personnel who have correct knowledge on how the appliance operates.

Transporting and moving your Lec Medical Freezer

The freezer must always be moved in the vertical position. The cabinet must not be tilted anymore than 40°. In the event that the cabinet is tilted more than 40°, the power supply must not be connected until the appliance has stood upright for at least 24 hours.

Energy saving tips

This appliance is cooled by energy-efficient R600a refrigerant. To keep running costs as low as possible always:

- Position the appliance away from heat sources.
- Make sure the air can circulate freely around the appliance, don't block ventilation grid.
- Ensure that products being stored in the appliance are below room temperature upon entry.
- Make sure the door is opened as little as possible whilst in use and closed as quickly as possible to prevent unnecessary temperature fluctuations.

Important Information

The freezer contains environment-friendly, non ozone depleting refrigerant R600a. As R600a is a flammable gas, it is important to avoid damage to the refrigeration circuit during transport and installation. If the refrigeration circuit is damaged, avoid using a naked flame in the vicinity of the freezer and connecting power to the freezer. Also make sure there is good ventilation in the room. If you are in doubt please contact your supplier.

- **WARNING:** Keep ventilation openings, in the appliance enclosure or in the built-in structure, clear of obstruction.
- **WARNING:** Do not use mechanical devices or other means to accelerate the defrosting process, other than those recommended by the manufacturer.
- **WARNING:** Do not damage the refrigerant circuit
- **WARNING:** Do not use electrical appliances inside the food storage compartments of the appliance, unless they are of the type recommended by the manufacturer.

Product Information

This freezer has been designed and built with the intention of the product being used within a Laboratory and is designed to store contents between -18°C and below.

Please see below for specific product information:

Model	Height (mm)	Width (mm)	Depth (mm)	Weight (Kg)	Refrigerant type	Ambient/Room working temperature	Door Type
LSF151	845	595	635	36	R600a	+10°C	Solid
LSF232	1565	595	670	60		to +32°C	Solid

Product details

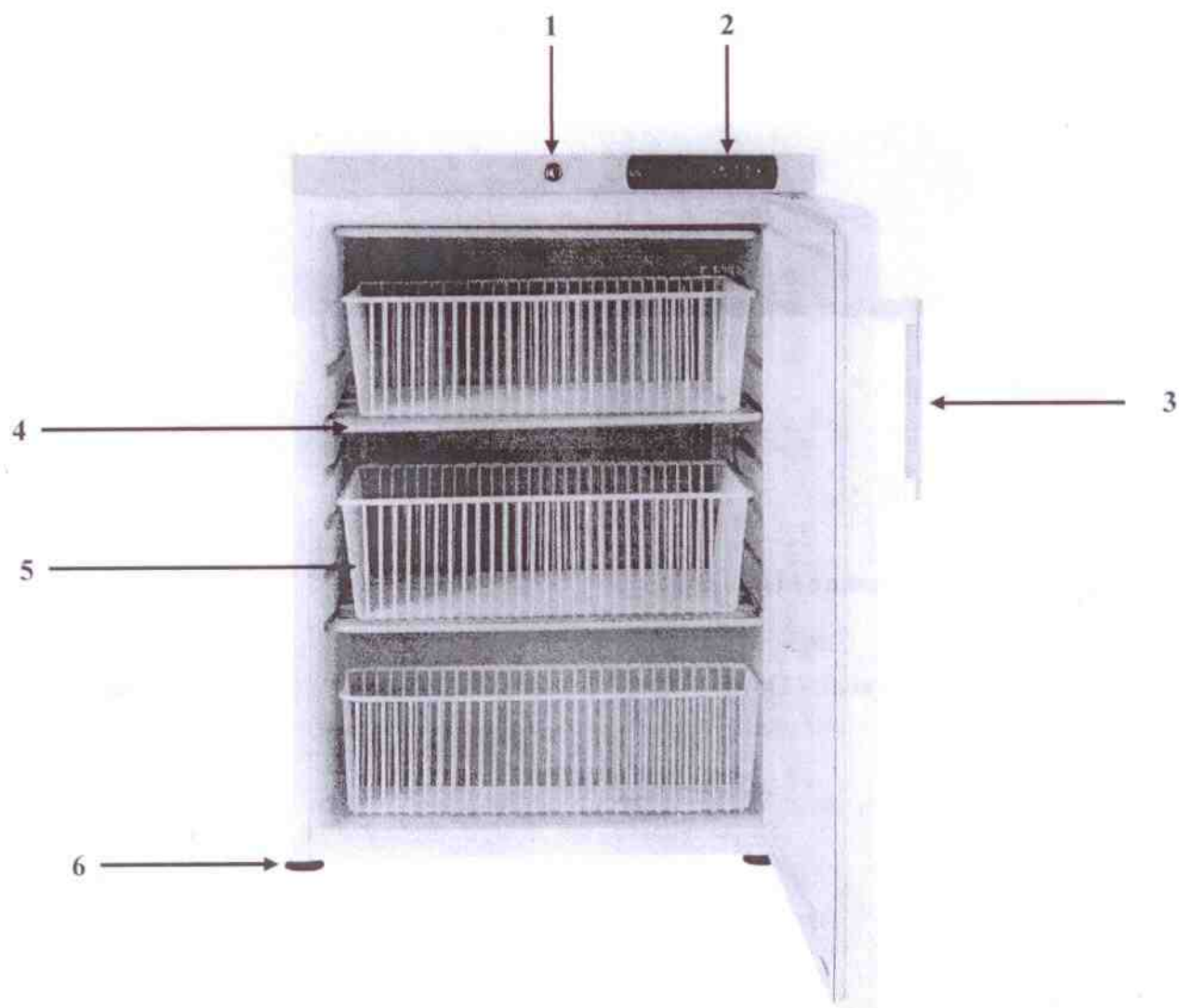

1. Lock
2. Electronic Controller
3. Antimicrobial handle
4. Wire Shelf
5. Wire Basket
6. Adjustable foot (2 at front of appliance)

There are also 2 roller castors at the rear of the appliance to ease product movement.





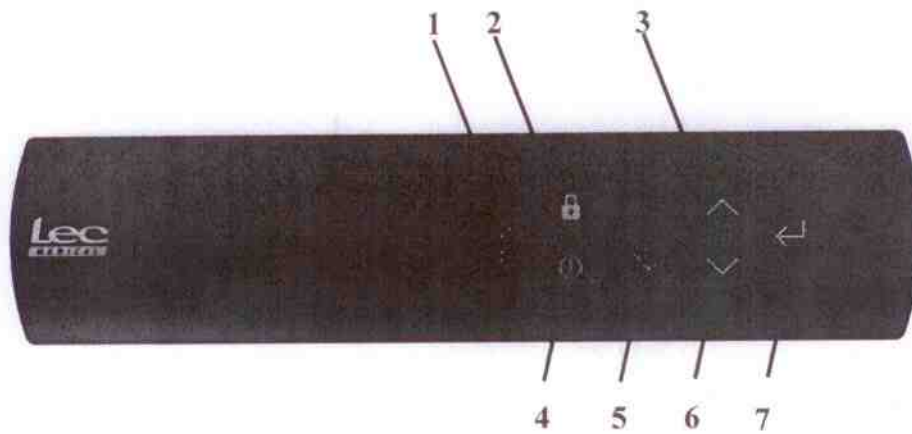





















Additional or replacement parts are available from our spare parts department. See back of booklet for contact details.

Controller overview and operation













1. Menu
2. Lock keypad
3. Maximum temperature / Up
4. Power
5. Mute
6. Minimum temperature / Down
7. Set / Enter

Viewing & resetting minimum and maximum temperatures











Function	Press	Hold button(s) down for	Example screen
To view Maximum air temperature <i>N.B. Displays maximum since last reset</i>		3 seconds	
To view Minimum air temperature <i>N.B. Displays minimum since last reset</i>		3 seconds	
To reset air temperature <i>N.B. This will delete all previous values</i>	 	3 seconds	
To view Maximum "load" temperature followed by followed by <i>N.B. Displays maximum "load" temperature since last reset</i>	  	3 seconds 1 second 3 seconds	  
To view Minimum "load" temperature followed by followed by <i>N.B. Displays minimum "load" temperature since last reset</i>	  	3 seconds 1 second 3 seconds	  
To reset "load" temperature <i>N.B. This will delete all previous values</i>	   	3 seconds 1 second 3 seconds	  

Changing the factory set point











(the set point is the point at which the freezer normally holds the temperature at; in some circumstances such as high/low room temperatures it may be necessary to adjust this slightly)

Function	Press	Hold button(s) down for	Example screen	
To change the set point		3 seconds		
	followed by		Once	
	followed by		1 second	 (current set point)
	followed by	 (Increase / Decrease)	up to 10 times	
	followed by		1 second	
Note: set point can be increased or decreased in +/- 0.1° increments by a MAXIMUM of 1°C				

Changing the temperature scale between Celsius (°C) and Fahrenheit (°F)

Function	Press	Hold button(s) down for	Example screen	
To change temperature scale		3 seconds		
	followed by		Two times	
	followed by		1 second	 (current scale)
	followed by		Once	
	followed by		1 second	

Changing the remote alarm contacts

Function	Press	Hold button(s) down for	Example screen
To change the alarm contact state		3 seconds	
followed by		Three times	
followed by		1 second	 (current state)
followed by	 / 	Once	
followed by		1 second	
Note: NO = Normally Open, NC = Normally Closed			

Warning Alarms

This freezer has been designed to provide both an audible and visual alarm should any of the following situations occur:

- Door is left open for a set period
- Internal air temperature goes outside the set parameters, either too high or too low
- Internal 'load' temperature goes outside the set parameters, either too high or too low

Should one of these alarms occur this can be muted by pressing  on the controller.

The 'load' temperature is a simulated temperature which is intended to provide an indication of the temperature of the freezer's contents (e.g. a 5ml vaccine). The temperature of a freezer's contents will change more slowly (up or down) than the air temperature within that freezer should there be a fault or the door is left open.

Remote alarm contacts

All Lec Medical laboratory freezers include remote alarm contacts and these terminal contacts enable the user to connect to a remote control station; these contacts can be found on the rear of the cabinet. **WARNING:** These contacts must only be accessed by a competent electrician.

In order to use these contacts the following must be carried out:

1. The freezer **MUST** be disconnected from the power supply before removing the terminal cover.
2. Unscrew the cover (figure 1) on the right hand side of the rear of the cabinet to expose the connectors (figure 2).



Figure 1

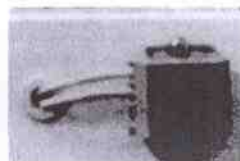

Figure 2

3. Use the right hand outer positions that correspond to the left hand cable positions for your connections using 0.75mm cable stripped to 0.6mm.
4. Depress the larger slot above the cable entrance on the right hand side with a small electrical screwdriver. This allows the cable to be inserted into the slot directly below.

In the event of a door open alarm, high or low temperature alarm or power failure a remote relay will switch within the controller to make an electrical circuit.

Please note that the contacts supplied are voltage free. A voltage of between 12V DC and 230V AC can be connected at the contacts. The maximum load must not exceed 2A. The minimum power rating is 500mA / 12V AC.

In a normal condition (i.e. no alarm) the relay OPENS the contact for the remote alarm facility.

In an alarm condition the relay CLOSES the contact for the remote alarm facility.

Maintenance and Service of your Lec Medical Freezer

Defrosting

All laboratory freezers require manual defrosting; before manually defrosting the cabinet, make sure the power lead is disconnected from the mains. Any loose frost found on the evaporator can be removed carefully using a wooden or plastic scrapper.

WARNING: Do not use any knives or sharp metallic objects to remove frost.

Cleaning

- Your freezer should be cleaned regularly.
- Before cleaning you **MUST** switch off and disconnect your freezer from the power supply.
- The whole freezer except the door gasket can be cleaned with mild cleaning detergent.
- The door gasket should be cleaned with water only and wiped dry.
- The antimicrobial handle should be cleaned regularly with soap and water.
- Remove shelves/basket/door furniture and wipe with a soft cloth. **DO NOT** put them in a dishwasher.
- Detergents containing abrasives or acids are not suitable for the cleaning.
- When all cleaning has been completed and accessories replaced, reconnect the plug with **dry hands**.

Reversing the door

In order to reverse the door please follow the below instructions. This should be carried out by 2 people for safety purposes.

1. Tilt the freezer backwards by 45° and lean on a vertical, hard surface such as a wall.
2. Remove the feet from the bottom, right hand hinge (figures 1 and 2).
3. Remove the screws from the hinge (figure 3) and remove hinge.

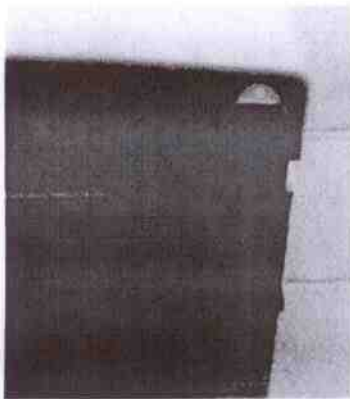

Figure 1

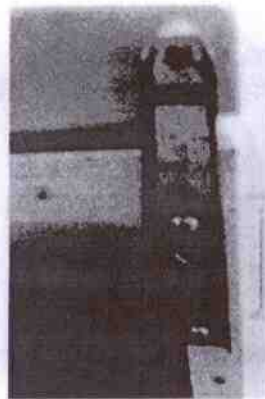

Figure 2

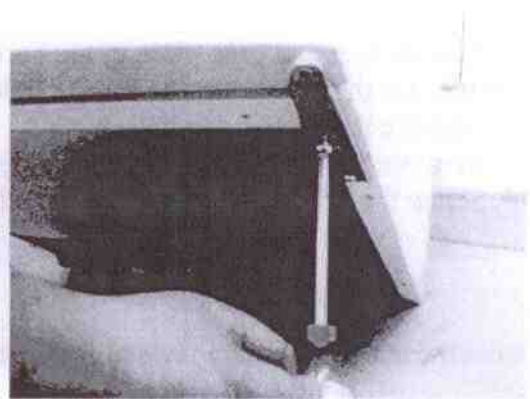

Figure 3

4. Pull the door from the bottom to remove from the freezer.
5. Remove the top, right hand hinge (figure 4).
6. Install the hinge on the top, left hand side (figure 5).

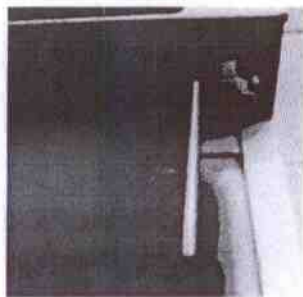

Figure 4



Figure 5

7. Remove the bottom, left hand feet and base plate (figures 6 and 7).

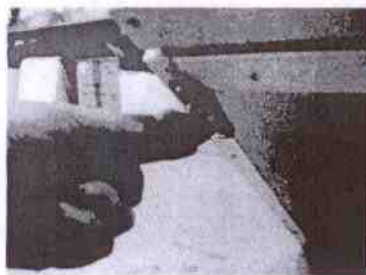

Figure 6

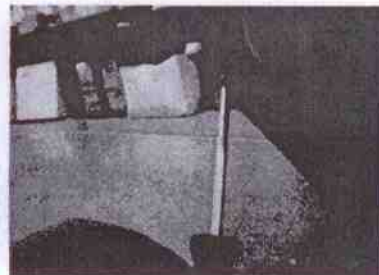

Figure 7

8. Insert the door into the top, left hand hinge (figure 8).
9. Install the bottom, left hand hinge (figure 9) and screw in the feet.



Figure 8



Figure 9

10. Add the feet and base plate to the bottom, right hand side.
11. Remove the caps from the screws holding the handle in position.
12. Remove the handle screws.
13. Remove the caps on the opposite side of the door.
14. Screw the handle into position and add the caps to cover the screws.

Storage

If the freezer is to remain unused for a period of time (e.g. during refurbishment work) switch the appliance off by pressing the power button  and disconnect the power supply to the cabinet at the wall socket. It is also advised that the appliance is unplugged from the power supply. Empty, defrost and clean the freezer. Make sure the door is left slightly ajar to prevent any bad odours forming within the cabinet.

Electrical Connection

The appliance is intended for connection to alternating current. The connection values for voltage (V) and frequency (Hz) are declared on the name plate in the cabinet. Power must be connected via a wall socket with a switch. It is strongly recommended that the wall socket is easily accessible. All earthing requirements stipulated by the local electricity authority. The cabinet plug and wall socket should give correct earthing. If in doubt, contact your local supplier or an authorised electrician.

If the supply cord is damaged, it must be replaced by the manufacturer, its service agent or similarly qualified persons in order to avoid a hazard.

WARNING: THIS APPLIANCE MUST BE EARTHED

The flexible cord (mains lead) fitted to this appliance has three cores for use with a 3-pin 13 amp plug. If a BS 1363 (13-amp) fused plug is used it should be fitted with a 13-amp fuse.

The cores in the mains lead are coloured in accordance with the following code:

GREEN AND YELLOW: EARTH

BLUE: NEUTRAL

BROWN: LIVE

These colours might not correspond with the colour markings identifying the terminals in your plug.

Note:

First Connection to the mains

The appliance provides information about the higher temperature (Hi alarm) till the moment of cooling.

The alarm is signalled by a sound signal and "Hi" caption on the display. To cancel the alarm, press any button.

Until the moment of cooling, the alarm is repeated every 15 minutes. Such an operating mode is normal until the required temperature settings are reached.

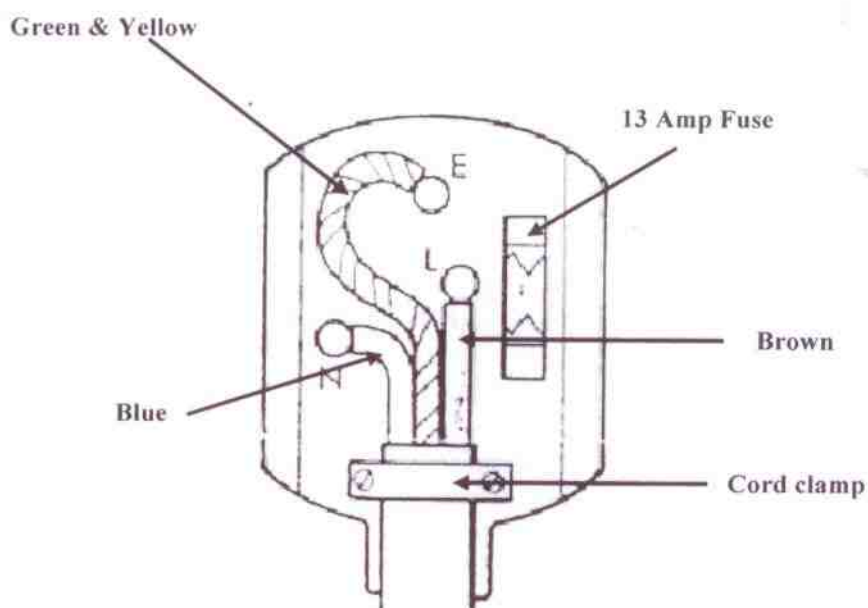

Disposal of your freezer

When disposing of your freezer do not take it to regular municipal waste containers. Instead, take it to an electrical/electronic waste recycling and re-use centre. This freezer contains insulation gases and refrigerant and must be disposed of in the appropriate manner. Please contact the manufacturer or local authority for advice on how best to dispose of this product.

A relevant label has been placed on the freezer's packaging (see below). The product has been manufactured of recyclable materials. Ask your local environmental care authority for information concerning location of such facilities.



Troubleshooting

PROBLEM	REASON	SOLUTION
The appliance does not work	A gap in the electric system circuit	<ol style="list-style-type: none"> 1. Make sure the plug is properly inserted into the socket 2. Make sure the socket is not faulty 3. Make sure the power supply cord is not damaged
	The compressor hardly ever activates	<ol style="list-style-type: none"> 1. Check to see if the ambient temperature is below +10C
The temperature inside the appliance is not low enough (the compressor operates continuously)	The door doesn't shut tight or is opened too often	<ol style="list-style-type: none"> 1. Rearrange the products so they don't hamper the door 2. Shorten the time the door is open for
	The ambient temperature is above that which has been outlined in the product specification (page 6)	<ol style="list-style-type: none"> 1. Check that the appliance is operating at an ambient temperature that meets the product specification on page 4
	Air circulation at the back of the appliance is hampered	<ol style="list-style-type: none"> 1. Move appliance further away from the wall
	The appliance is placed such that it is subject to constant sunlight, or another heat source e.g. Radiator	<ol style="list-style-type: none"> 1. Move the appliance to a different place away from heat sources or direct sunlight
Water collects at the bottom part of the refrigerator	The contents touch the back wall of the cabinet	<ol style="list-style-type: none"> 1. Move the products so they aren't in contact with the back wall
	The drain opening is clogged	<ol style="list-style-type: none"> 1. Take the cleaning plug and unclog the condensate opening
The appliance makes too much noise	The appliance is not level	<ol style="list-style-type: none"> 1. Place the appliance on an even surface or use adjustable feet
	The appliance is touching another object	<ol style="list-style-type: none"> 1. Reposition the appliance so it is detached from any other objects